



LXNAVIGATION

Traffic square

user's manual



LX Traffic Square



Device manual

- LX navigation -

May, 2025



Tkalska ulica 10
SI-3000 Celje
Tel.: 00 386 3 490 46 70
Fax.: 00 386 3 490 46 71
info@lxnavigation.com
www.lxnavigation.com



Document information

0.1 Abstract

This document represents the user manual for the LX Traffic Square. The installation manual, dataport and additional info can be found on www.lxnavigation.com.

0.2 Document status

Document status: PUBLIC

Document status	Explanation
Internal	Intended only for LX navigation staff
Public	Available publicly to all
Personal	Intended for a specific person and/or company, noted on this page
Dealer	Intended for a specific dealer, noted on this page
Manufacturer	Intended for a specific manufacturer, noted on this page

0.3 List of applicable products

Device	Version	Build
LX Traffic Square	V1.0	377

0.4 Revision history

Document name	Document revision	SW version	Build	Date	Revised by	Approved by	Notes
LX_SQUM	R1	1.0		22.2.2021	L.R.	N.S.	LaTeX edition
	R2	1.0	1215	13.2.2023	A.S.	N.S.	Flarm page details icons

Contents

0	Document information	3
0.1	Abstract	3
0.2	Document status	3
0.3	List of applicable products	3
0.4	Revision history	3
1	Important notices	6
1.1	Using this manual	6
1.2	Device operating limits	6
1.3	Limited warranty	6
1.4	Sunburned display	7
1.5	Disclaimer/EULA	7
2	Getting started	8
2.1	Device overview	8
3	Basic operation	10
3.1	Turning the LX Traffic Square on	10
3.2	Device interface	11
3.3	User input	12
3.3.1	Left-right motion	12
3.3.2	Up-down motion	12
3.3.3	Short-press	12
3.3.4	Long-press	12
3.3.5	Really long-press	12
3.4	Performing an update	13
3.5	Turning the LX Traffic Square off	13
4	Advanced operation	14
4.1	Flarm radar page	15
4.2	Navigation pages	19
4.2.1	The map	19
4.2.2	The Header	19
4.2.2.1	The NavBox line	20
4.2.3	Turnpoint navigation page	21
4.2.3.1	Choosing a Turnpoint	23
4.2.4	Airport navigation page	24
4.2.5	GPS DATA INVALID	25
4.3	Info page	26
4.4	Logbook/Flight statistics page	26
4.4.1	Logbook	26



4.4.2	Flight statistics	27
5	Device setup	28
5.1	User settings	28
5.1.1	Voice	28
5.1.2	Pages	28
5.1.3	Graphics	29
5.1.3.1	Airspace	29
5.1.3.2	Map	29
5.1.3.3	Theme	30
5.2	System settings	31
5.2.1	Aircraft	31
5.2.2	Units	31
5.2.3	NMEA	31
5.2.4	Transfer	32
5.2.4.1	Turnpoints	33
5.2.4.2	Airports	33
5.2.4.3	Airspace	34
5.2.4.4	Flarm NET	34
5.2.5	Localisation	34
5.2.6	Service	35
6	Taking care of your LX Traffic Square	36
6.1	Display	36
6.2	Device housing	36
6.3	RJ connectors	36
6.4	MicroSD card reader	36
6.5	Reverse polarity on power	37
7	Contact	38



Important notices

1.1 Using this manual

This manual has been created in L^AT_EX, giving us the possibility of linking up everything we find linkable. You will find references to other parts of the manual, to other manuals, webpages, etc. throughout the manual.

Linkable content will be **bold and underlined**, i.e. you can find additional info on how to take care of your LX Traffic Square in the **Taking care of your LX Traffic Square** section of this manual (click on the underlined text).

NOTE

The most recent version of this manual will always be available at
<https://lxnavigation.com/support/>

1.2 Device operating limits

This instrument may be used under VFR (Visual flight rules) only! Any navigational information is provided for reference only. The pilot takes all responsibility and risk associated with the use of this device.

Have a nice flight.

1.3 Limited warranty

This device is warranted to be free from defects in materials or workmanship for two years from the date of purchase. Within this period, LX navigation will, at its sole discretion, repair or replace any components that fail in normal use. Such repairs or replacements will be made at no charge to the customer for parts and labour, the customer shall be responsible for any transportation cost. This warranty does not cover failures due to abuse, misuse, accident, or unauthorized alterations or repairs.

THE WARRANTIES AND REMEDIES CONTAINED HEREIN ARE EXCLUSIVE AND IN LIEU OF ALL OTHER WARRANTIES EXPRESSED OR IMPLIED OR STATUTORY, INCLUDING ANY LIABILITY ARISING UNDER ANY WARRANTY OF MERCHANTABILITY OR FITNESS FOR A PARTICULAR PURPOSE, STATUTORY OR OTHERWISE. THIS WARRANTY GIVES YOU SPECIFIC LEGAL RIGHTS, WHICH MAY VARY FROM COUNTRY TO COUNTRY. IN NO

EVENT SHALL LX NAVIGATION BE LIABLE FOR ANY INCIDENTAL, SPECIAL, INDIRECT OR CONSEQUENTIAL DAMAGES, WHETHER RESULTING FROM THE USE, MISUSE, OR INABILITY TO USE THIS PRODUCT OR FROM DEFECTS IN THE PRODUCT.

Some countries do not allow the exclusion of incidental or consequential damages, so the above limitations may not apply to you. LX navigation retains the exclusive right to repair or replace the unit or software, or to offer a full refund of the purchase price, at its sole discretion. SUCH REMEDY SHALL BE YOUR SOLE AND EXCLUSIVE REMEDY FOR ANY BREACH OF WARRANTY. To obtain warranty service, contact your local LX navigation dealer or contact LX navigation directly.

The manufacturer does not take the responsibility for possible mistakes or misprints in this text and gives no guarantee for accuracy of this manual. This manual has been written with the greatest care and we have done our best to avoid any mistakes but with all respect please check any doubtful statement and let us know. We would be very grateful and we thank you in advance for any comment.

1.4 Sunburned display

Damages to the device, especially the display part, are not covered by the warranty and will be considered as misuse of the device. To learn how to take care of your display and device in whole, check the **Taking care of your LX Traffic Square** section of this manual.

1.5 Disclaimer/EULA

LX navigation reserves all rights to this document and the information contained herein. Products, names, logos and designs described herein may in whole or in part be subject to intellectual property rights. Reproduction, use, modification or disclosure to third parties of this document or any part thereof without the express permission of LX navigation is strictly prohibited. The information contained herein is provided "as is" and LX navigation assumes no liability for the use of the information. No warranty, either express or implied, is given, including but not limited, with respect to the accuracy, correctness, reliability and fitness for a particular purpose of the information. This document may be revised by LX navigation at any time. For most recent documents, please visit **www.lxnavigation.com** or contact **info@lxnavigation.com**. Copyright © 2020, LX navigation d.o.o.



Getting started

2.1 Device overview

The LX Traffic Square is a **collision avoidance flight display** compatible with **all** types of **Flarm devices**. It is commonly used in gliders, ultralights and experimental aircraft. Additional to providing **audio and visual collision avoidance warnings** and a **Flarm radar display**, the Traffic Square offers the pilot **two dedicated moving map navigation pages**. These pages offer simultaneous navigation to a **Turnpoint** and **Airport**.

Using a Flarm device with an **ADS-B module** will offer the pilot ADS-B warnings as well.

It offers the same functionality of the LX Traffic Monitor, but in a more compact square package.

The device features a transfective technology display.

The LX Traffic Square's primary function is to alert the pilot of an on-coming collision with audio and visual warnings. The secondary function is to show the pilot all Flarm and ADS-B (if an ADS-B module is installed) objects on the Flarm radar page and the tertiary function is to act as a simple navigation device.

The device is designed for simple pilot operation with a single 4-way push-button that features both short and long-press functions.

The unit is capable of providing **APT (airport)** and **TP (turnpoint)** navigation on two dedicated navigation pages. Navigation pages feature navboxes, showing bearing to point, track, distance, ground speed and altitude. It also shows airspace, airports and turnpoints on the map.

There is a dedicated logbook page, listing all flights with date, take-off and landing times and flight duration.



The LX Traffic Square features:

- 2.7 inch transfective technology sunlight readable display
- 4-way push-button with short and long-press functions, for simple and effective handling
- Internal beeper (for Flarm warning)
- Flarm-IN port (input of Flarm data)
- Flarm-OUT port (for connecting other Flarm devices)
- Voice-OUT (Audio-OUT)
- Voice module as an integrated part of the system
- External SD Card interface for firmware updates and TP/APT/Airspace transfers

Functions:

- Complete TP/APT navigation with airspace information and warnings
- Flarm radar screen
- Logbook
- Voice announcement

The unit has the capability of being updated to any later firmware release free of charge.



Basic operation

We will go through the basic gestures and what they do on all pages of the LX Traffic Square system.

The Traffic Square uses a single 4-way push button with both short and long-press functions.

3.1 Turning the LX Traffic Square on

The LX Traffic Square is turned on automatically when power is supplied to the Flarm port, meaning it does not have a turn-on and shut-down option.

Once the device is turned on, a sequence of screens will appear in the following order:

- **LX navigation greeting screen**
- **Second screen** stating the device type, serial number and firmware version

WARNING

When the device is turning on, a warning may appear, indicating limited operation capability to the pilot. You should contact **LX support** as soon as possible. The device might be operable even with the warning present, but full operational capability is not guaranteed.

- **Internal memory error** - there is an issue with the internal memory of the device. Device will continue to operate and show Flarm warnings, but some pictures and assets may be corrupted.

3.2 Device interface

The LX Traffic Square features a single 4-way push-button with both short and long-press functions.

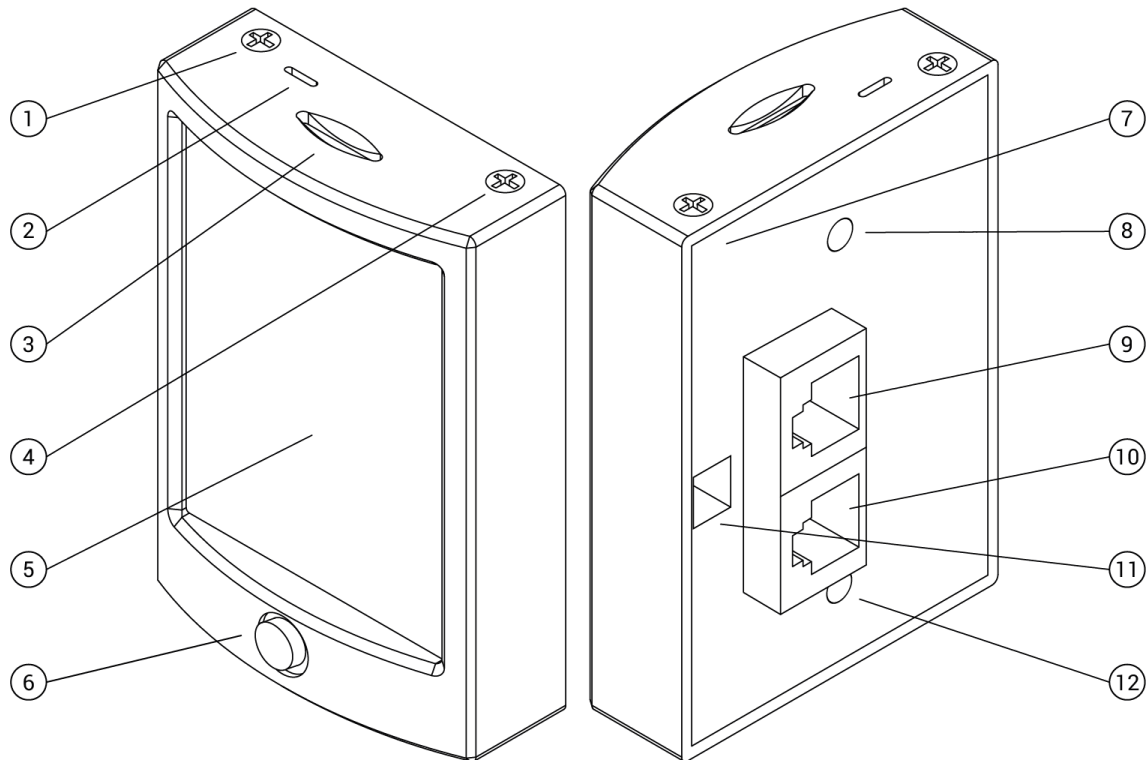

Figure 1. LX Traffic Square front plate interface

On the front plate, we can see the following items:

- | | |
|--------------------------------|-------------------------|
| 1. Housing screw | 7. Device back-plate |
| 2. Beeper opening | 8. Mounting screw hole |
| 3. MicroSD card reader opening | 9. RJ45 8-pin port |
| 4. Housing screw | 10. RJ45 8-pin port |
| 5. Device screen | 11. Audio connector |
| 6. 4-way push-button | 12. Mounting screw hole |

The device is capable of providing AUDIO-OUT both for Flarm warnings, as well as for the built-in voice module. Instead of using the 3.5 mm jack, we have a special connector. You can get the connector with 2 open-wire cables for connecting to your speaker of choice or an intercom in a powered airplane, to receive audio warnings in the headset, as an accessory.

Additionally, we offer the following accessories:

- **Flarm cable** - a single 1:1 RJ45 to RJ45 8-pin cable for connecting to a Flarm device (included in standard package)
- **57 mm round cutout to Square adapter** - for easy installation
- **80 mm round cutout to Square adapter** - for easy installation



- **AUDIO-OUT adapter cable** - for connecting to a speaker or intercom

NOTE

Please note that the device can only be used in landscape mode.

We will name the different movements of the 4-way push button by their functions:

- **LEFT-RIGHT** - Pages - Changes between pages
- **UP-DOWN** - Zoom - zooms on zoomable pages
- **Short press** - Enter - enters page, text dialog, confirm etc
- **Long press** - Sub-page - opens additional sub-page on pages that have them (mainly navigation pages for additional info for navigation points)

3.3 User input

The 4-way push-button's operation can be divided into left-right and up-down motion with appropriate short and long-press functions.

3.3.1 Left-right motion

Left-right motion is used for the following functions:

- **Changing between primary pages**

3.3.2 Up-down motion

Up-down motion is used for the following functions:

- **Zooming**, on all zoomable pages
- **Scrolling** through menus and choosing letters and number in alphanumeric dialogues

3.3.3 Short-press

Short-pressing (1s) the push-button will act as 'enter', 'confirm', 'yes', 'open', etc.

3.3.4 Long-press

Long-pressing (3s) the push-button will act as 'open sub-page', 'exit', 'back'. The latter two only when in a sub-page.

3.3.5 Really long-press

Really long-pressing (10s) the push-button will perform a hard-reset of the device.



3.4 Performing an update

In order to be on track with the latest software releases, follow our [Support webpage](#). Once you find an update, download it to your computer.

Once you've downloaded the update file, follow these steps:

1. Copy the desired software update file to the root of the microSD card. The update file should have the word Traffic Square within its name (or something like TrfSqr) and an extension of .lxu. Be sure to use the supplied SanDisk Ultra microSD card.
2. Insert the microSD card and turn the device on
3. Go to **Setup > Service > Software update**
4. Select the desired update file
5. If prompted for an update code, type in '00000'.
6. The device will copy the file to the internal memory and perform the update. It may restart a couple of times.
7. Once the update has finished, verify that the update has been successful by going to **Setup > Service > Device info** and checking that the SW version has changed to the desired one

NOTE

The LX Traffic Square will restart during the update procedure.

WARNING

Great care should be taken not to turn the device off while the updating process is running, not to restart it or cut the power supply. Data corruption may occur. If something similar happens, contact LX support immediately, in order to recover your unit.

3.5 Turning the LX Traffic Square off

The Traffic Square turns off automatically when the power supply is cut.



Advanced operation

Primary pages overview

This section will cover the complete specter of operations possible on LX Traffic Square's primary pages.

There are 6 primary pages on the LX Traffic Square. You can scroll between these pages by using the right-left movement of the push-knob. The pages are listed as follows:

1. **Flarm radar page**
2. **Turnpoint navigation page**
3. **Airport navigation page**
4. **Info page**
5. **Logbook/Flight statistics page**
6. **Setup page**

4.1 Flarm radar page

The Flarm radar page shows all surrounding objects reported to the LX Traffic Square by a Flarm device. If the said Flarm device has an ADS-B module, the LX Traffic Square will show ADS-B objects as well. Flarm objects are shown on a radar screen with track-up orientation.



Figure 2. Flarm radar screen



Figure 3. Flarm radar select circle

Objects presented as a dot on the screen are objects where pilots have intentionally activated the PRIVACY mode on their Flarm unit. Objects in privacy mode send limited data strings and can't be visualized completely. However, all warnings will appear regardless of privacy mode.

It will also display 'non-directional' traffic. This is traffic reported by some Flarm devices with built-in ADS-B receiver capable of receiving Mode-S transponders (example of such a device is LX navigation Flarm Eagle with ADS-B). Non directional traffic is displayed as a circle around the object.

Short-pressing the push-button will invoke the selection of a Flarm object to follow. For a selected object, additional details will be displayed in the corners of the screen, as depicted on Flarm radar select circle.

The following icons are used for each parameter:

-  - **Climb rate**
-  - **Horizontal distance**
-  - **Vertical distance**
-  - **Ground speed**

Moving the push-knob up and down will change the zoom of the flight radar screen and long-pressing it will open the Flarm objects sub-page. In the Flarm sub-page, a list of all visible aircraft is shown. A green dot next to the name of the object shows which object has been select for additional info on the Flarm radar page. Object ID and distance is also shown.

By choosing an object and pressing the push-button, additional information can be seen and/or edited, for each object:

- **Callsign**
- **Pilot**
- **Airfield**
- **Registration number**
- **Frequency**
- **Flarm ID (always non-changeable)**



The LX Traffic Square supports FlarmNET database files, check **Flarm NET** section for additional information.



Figure 4. List of visible Flarm objects

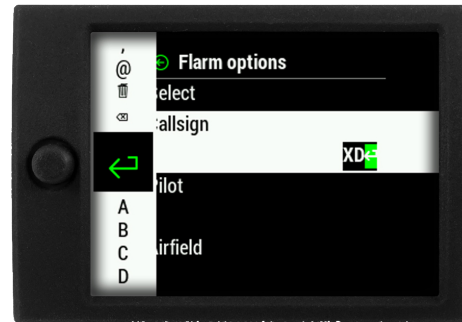

Figure 5. Additional info for objects

An important safety feature of the LX Traffic Square is the Flarm warning page. This page pops-up whenever the Flarm device sends a warning sentence, regardless of the menu, page or setup you're currently in.

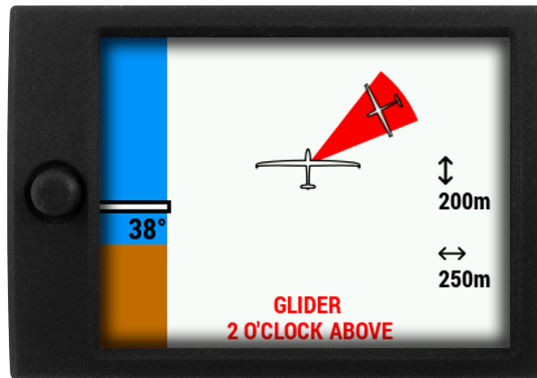









Figure 6. Flarm warning page

The Flarm warning screen shows the type of object the Flarm is warning you about, from the list of supported Flarm objects (Glider shown on figure). It's relative direction to your heading, relative altitude and distance, as well as an angle from the horizon, with the blue/brown scale on the left side of the screen. The relative direction of the object is also written in word with **GLIDER 12 O'CLOCK ABOVE**.

The LX Traffic Square can show the following objects with appropriate graphics:

- **Glider** - 
- **Hang-glider** - 
- **Balloon** - 
- **Tow plane** - 
- **Para-glider** - 
- **Blimp, zeppelin** - 
- **Helicopter** - 
- **Powered ac** - 
- **UAV** - 
- **Skydiver** - 
- **Jet aircraft** - 
- **Obstacle** - 
- **Drop plane** - 
- **UFO** - 

NOTE

A lot of effort was put into the design of the Flarm Warning screen, shown by figure 34. It's sole purpose is to quickly familiarize the pilot with the potential danger. Flarm provides us with three distinctive levels of danger:

- **13 to 18 seconds to impact** - the Flarm Warning screen appears, the LX Traffic Square's internal beeper and the flashing of the direction cone are in the same, steady frequency. The lady from the LX Traffic Square's internal voice module notifies you of the location of the object.
- **9 to 12 seconds to impact** - same as previous level, both the internal beeper frequency and beeping interval, as well as the flashing interval, intensify (higher frequency)
- **0 to 8 seconds to impact** - as on previous level, with the highest frequency of beeping and flashing.

4.2 Navigation pages

The LX Traffic Square offers 2 separate navigation pages, giving the pilot simultaneous navigation to a **turnpoint & airport**.

The basic layout of each navigation page is the same. In the top of the page, we can see the header. Below the header, we can see the moving map. A zoom scale is present and in the bottom of the page, the NavBox line is positioned.

Long-pressing the **push-knob** will show additional info for the point we're currently navigating to on the **turnpoint & airport**. Moving the push-knob up and down will change the zoom level.

Short-pressing the **push-button** will open the turnpoint or airport selection sub-page.

4.2.1 The map

The Turnpoint navigation page is based on a map, covering the central part of the screen. The map shows **turnpoints and airports** with small circles and their names, as well as **airspace lines**.

On the Map, an aircraft icon represents your current location. The LX Traffic Square supports both North-up and Track-up orientation, which can be set in the **Graphics** section.

On the right, the map scale is shown.



Figure 7. A navigation page

Two lines can be seen on the screen, starting at the aircraft. The first one is showing the direction of your movement, your track, and the second one is showing the direction to your chosen turnpoint, the destination line. Colours can be changed in the **Graphics** setup menu.

4.2.2 The Header

The Header represents the top part of the screen, covering three vital pieces of information: **Page name**, **Turnpoint name** and **Relative bearing**.



In the far top of the screen, we can see '**TP:**' written. The **TP** indicates that we are on the **Turnpoint navigation page**. After the colon, the name of the turnpoint to which we are navigating to is displayed.

Next to the turnpoint name, relative bearing is shown in degrees. When the relative bearing is 0, we are flying towards the turnpoint.

Since the relative bearing is calculated from the bearing to turnpoint and your current **track** (not heading), **the wind is already calculated into the relative bearing**.

On either side of the relative bearing, a green arrow will show in which direction you should turn by the noted amount of degrees in order to be on course for the turnpoint.

4.2.2.1 The NavBox line

In the lower part of the screen a **NavBox line** containing 4 NavBoxes is shown. **Ground speed, Track, Bearing** and **Distance** to turnpoint are shown.

4.2.3 Turnpoint navigation page

This page is used for navigating towards a single turnpoint, from the .cup file, loaded into the LX Traffic Square. The navigation screen shows turnpoints, airports and airspaces.



Figure 8. Turnpoint page overview

Basic operation on this page has been explained in the [Navigation pages](#) section. Here, we will explain some specifics of the Turnpoint navigation page, and how to perform basic Turnpoint operations.

Long-pressing the **push-knob** will open the TP info sub-page, showing Bearing, Distance, Surface type and Elevation, if available.



Figure 9. Turnpoint additional info

Above the Bearing, an arrow is shown. The direction of the arrow indicates the steering course, relative to your current track.

Short-pressing the **push-button**, while on the navigation page, you will enter the 'Select turnpoint' sub-page. Here, a selection of turnpoints will be shown, along with distance and bearing, as well as **(relative bearing)** as described earlier, with an arrow. These points can be sorted by either Distance, Name, or Code.

Choosing Name or Code will open up the Filter setting, where you can type the name or code



lettering. Choosing a turnpoint will set the turnpoint as the navigation point for the turnpoint navigation page.

For additional info on how to install database files, check the **Transfer** section of this manual.

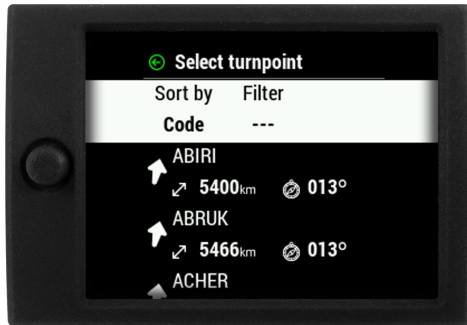

Figure 10. Turnpoint selection sub-page



Figure 11. Search by name



4.2.3.1 Choosing a Turnpoint

To recap on how to choose a Turnpoint for navigation, follow these steps:

0. Have a .cup file loaded and selected
1. Go to the Turnpoint navigation page
2. Short-press the **push-button**
3. Select the sorting criteria **Name, code and distance available**
4. Type in the Name or code if Name or code are chosen as sorting criteria
5. Scroll the list until you find the desired turnpoint. You can scroll regularly with the up-down movement of the push-button
6. Confirm the desired point by pressing the push-knob
7. The device will automatically take you back to the Turnpoint navigation page and start navigating to the desired turnpoint.

NOTE

In order to use navigation pages to their full extent, be sure to have airspace (.cub), turnpoint (.cup) and airport (.af) files installed. Some of these, like .cup and .cub files, are available on competitions, from club managers, or governing national air bodies (like DAeC) or can be created by yourself manually, while other, like the .af file, are provided solely by LX navigation.

NOTE

Files provided by LX navigation (.cub and .af) can be found on <https://lxnavigation.com/support/>. LX navigation does not provide official .cup files, for unofficial turnpoint files, you can check with your club mates and webpages like <https://www.openflightmaps.org/>.

4.2.4 Airport navigation page

The Airport navigation page is set up in much the same way as the **Turnpoint navigation page**, so be sure to check the previous section for additional information.

This page is used for navigating towards a single airport, from the .af file loaded into the LX Traffic Square. The navigation screen shows turnpoints, airports and airspaces on the map area.



Figure 12. Airport navigation page overview

Basic operation on this page has been explained in the **Navigation pages** section. Here, we will explain some specifics of the Airport navigation page, and how to perform basic Airport operations.

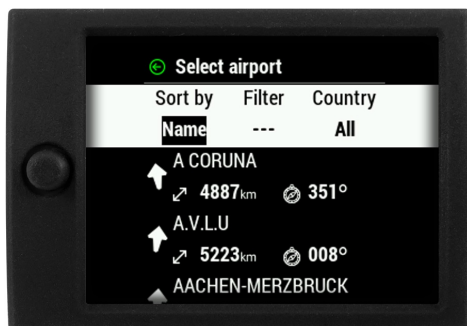

Figure 13. Airport selection sub-page



Figure 14. Airport additional info sub-page

Long-pressing the **push-knob** will open the APT info sub-page, showing Bearing, Distance, Surface type, Elevation, Airport Frequency and Runway directions.

Short-pressing the **push-button**, while on the airport navigation page, you will enter the 'Select airport' sub-page. Here, a selection of airports will be shown, along with distance and bearing, as well as steering course (relative bearing) as described earlier, with an arrow. These points can be sorted by either Distance, Name, or ICAO code.

Choosing Name or ICAO will open up the Filter setting, where you can type the name or code lettering. Choosing an airport will set the airport as the navigation point for the airport navigation page.

NOTE

When selecting an airport, the lady from the LX Traffic Square's internal voice module will notify you over the speaker of the runway's direction and airport frequency.

4.2.5 GPS DATA INVALID

If you lack a GPS connection, there will be a red cross across the screen and 'GPS DATA INVALID' written in a notification box.

If this happens, check that your device is connected to a GPS source (Flarm device), that it has a clear line of sight from the GPS antenna to the sky, and wait for the device to connect.

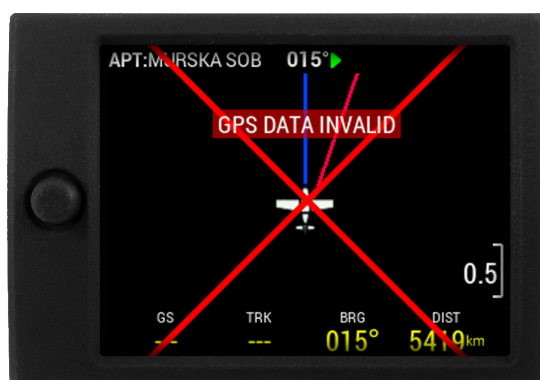

Figure 15. GPS DATA INVALID

4.3 Info page

The info page shows the current GPS status and additional info, received from the GPS, like the GPS location, UTC time and date.

The device shows the battery voltage of the LX Traffic Square's external (airplane) power supply.

Lastly, the page shows the Flarm connection status, and Flarm device ID. You can use this ID to register the device at OGN network.



Figure 16. Info page overview

4.4 Logbook/Flight statistics page

This page can be either the 'Logbook' or 'Flight statistics page, based solely on if the device is in flight mode.

4.4.1 Logbook

When the device is not in flight mode, this page will be in Logbook mode.

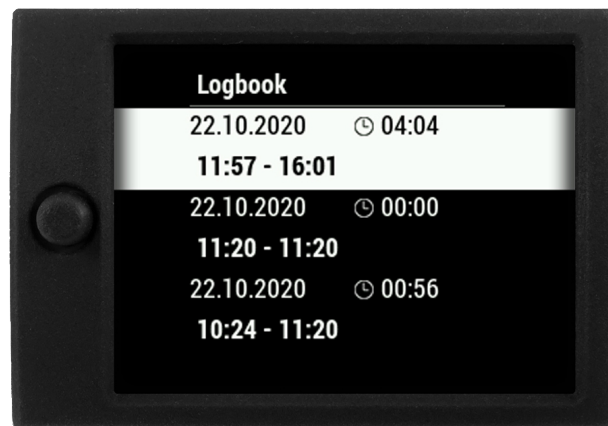

Figure 17. Logbook page

Entering the Logbook page will show the list of all flights the LX Traffic Square has in its memory. You can move up-down the list with the up-down movement of the push-button.

4.4.2 Flight statistics

Once the device enters flight mode, the Flight statistics page appears.

We can see the take-off time, flight duration, maximum altitude and maximum indicated airspeed, as well as an altitude graph.

NOTE

Once the LX Traffic Square determines that you are not in flight, it will start the 5 minute countdown to finishing your flight.

The conditions for finishing a flight are:

- GPS lock
- Ground speed less than 10 m/s
- Altitude less than 3000 m QNH

NOTE

If you wish to forcefully finish a flight, prior to the LX Traffic Square starting the finish procedure, you can do this by going to the 'Flight statistics' page and pressing the push-knob and confirming the 'End flight?' question.

WARNING

If the LX Traffic Square turns off due to the external power supply being cut, the flight might not be logged.

Device setup

This section will go through the complete setup process for the LX Traffic Square. It is important to note that the Setup menu is divided into two sections - the **User** and **System** settings.

Settings in the User setting part of the menu tailor the user experience with features such as Voice & sounds, Active pages and Graphics.

The System part of settings embodies system settings, including Units, NMEA settings, Transfer, Localisation and Service options.

5.1 User settings

The user part of setup incorporates the following sub-menus:

- Voice
- Pages
- Graphics

5.1.1 Voice

The Voice setup sub-menu holds the volume and mixer options for voice warnings, as well as a list of available voice warnings to choose from.

- **Volume**
- **Mixer**
- **Flarm traffic**
- **Flarm warning**
- **Flarm obstacle**
- **Flarm h. distance**
- **Flarm v. position**

5.1.2 Pages

The pages setup sub-menu provides the pilot with a list of all primary pages. The pilot can choose to show or hide different pages, i.e. hiding the TP navigation page if you lack the need for it.

- **Flarm**
- **TP page**
- **APT page**
- **GPS info**

5.1.3 Graphics

The Graphics sub-menu provides the pilot with options for personalizing the graphical appearance of the LX Traffic Square.

The following sub-pages exist:

1. **Airspace**
2. **Map**
3. **Theme**

5.1.3.1 Airspace

The airspace sub-menu holds the settings for colour and transparency of the fill and outline for the following airspace types:

- **Controlled zone**
- **Prohibited**
- **Restricted**
- **Danger**
- **Terminal area**
- **Airway**
- **Glider**
- **Military**
- **Other**
- **Class A, B**
- **Class C**
- **Class D**
- **Class E**
- **Class F**

5.1.3.2 Map

The Map sub-menu holds settings for the graphical appearance of the Map are on all navigation pages. The following settings are available.

- **Orientation** - offers the two common map orientations - 'North up' and 'Track up'.
- **TP/APT text size** - changes the size of airports and turnpoints names on the map.
- **Dest. line colour** - the colour of the line connecting your current position and your navigation point.
- **Track line colour** - the colour of the line showing your current true track.
- **Display APT names** - whether or not to display airport names (alongside the icon) on the map.
- **Display TP names** - whether or not to display turnpoint names (alongside the icon) on the map.



NOTE

APT icons are shown on the map up to a zoom level of 25km. TP icons are shown up to a zoom level of 9km. At higher zoom levels we are only showing Airspace lines, due to legibility.

5.1.3.3 Theme

The Theme sub-menu offer the pilot to choose between 2 themes. White panel uses the white colour for background and black and black text, while the black panel uses the black colour for background and white colour for letters.

WARNING

Changing the theme will cause the unit to instantly restart. Changing the theme in flight is not possible, due to this reason.

NOTE

Experience has shown that in high sunlight conditions, the 'White panel' colour theme is most visible, while the 'Black panel' colour theme is least straining for the eyes in low light conditions. Of course, sometimes it is just a matter of taste, which means **De gustibus non est disputandum.**

Due to the transfective display we recommend using the white theme. The white theme enables the transfective LCD panel to reflect the light from environment (eg. Sun) back to the user. This type of screen is visible in any ambient light conditions.









5.2 System settings

5.2.1 Aircraft

The following aircraft associated settings can be found in this sub-menu:

- **Category** - which category of aircraft does your aircraft belong to. Changing this will change the aircraft icon, as depicted with the aircraft icons selection below.

Aircraft icon selection:

- **Airplane** - 
- **Rotorcraft** - 
- **Jet** - 
- **Glider** - 
- **Gyrocopter** - 
- **Fighter** - 
- **Motor glider** - 
- **Airship** - 

5.2.2 Units

Sets the units used for different parameters throughout the device. The following parameters and units are available:

- **Altitude** - meters [m] or feet [ft]
- **Climb rate** - meters per second [m/s], knots [kts] or feet per minute [fpm]
- **Speed** - kilometers per hour [km/h], miles per hour [mph] or knots [kts]
- **Wind speed** - kilometers per hour [km/h], miles per hour [mph], knots [kts] or meters per second [m/s]
- **Distance** - kilometers [km], nautical miles [nm] or statute miles [mi]
- **Pressure** - hectopascal [hPa], inches of mercury [inHg] or millibars [mb]
- **Temperature** - degrees Celsius [C] or degrees Fahrenheit [F]
- **Weight** - kilograms [kg] or pounds [lb]
- **Aera** - square meters [m²] or square feet [ft²]

5.2.3 NMEA

The LX Traffic Square acts as a pass-through device for NMEA data received from the Flarm through the **DATA IN** port and forwards it through the **DATA OUT** port.

The pilot can set the bauderate of both the incoming and outgoing data by selecting one of the options between **4800** & **11520**.

5.2.4 Transfer

The Transfer sub-menu setup page holds all microSD transfer related options. In this setup page, we will see how to transfer database files, load tasks and FlarmNET files.

WARNING

LX navigation provides database files on an informative level and can in no way be held accountable implicitly, or otherwise, for and damage, be it material, personal or other, that may occur due to the use of this device. It is the pilot's responsibility to abide to all rules of air safety and to utilize good airmanship practice. In this sense, information provided by the LX Traffic Square is of an informative nature only and should be taken with reserve. No guarantees are made on the accuracy of information found in databases released by LX navigation.

WARNING

It is important to note, that some microSD cards of lower quality may cause issues and not be read by the LX Traffic Square. This is why we strongly recommend you use the supplied SanDisk Ultra red/grey micro SD card, supplied with the device, as depicted on the figure below. The microSD card should be formatted to the FAT32 file system. Cards of up to 32 GB of memory were successfully tested on the LX Traffic Square.



Figure 18. The correct type of microSD

NOTE

Pilot must be careful not to exceed the file size of 750 kB, except "FlarmNET" file, where the max file size of 5 MB is allowed.

NOTE

If you have just inserted the microSD card into your LX Traffic Square unit and the files are not showing up, try leaving the transfer setup page and entering again.

5.2.4.1 Turnpoints

Turnpoint files, in the .cup file format, are not supplied by LX navigation, but can usually be found at competitions, various webpages or from club manager and club mates. As a starting point, you can check the [Open flight maps](#). You can even create your own turnpoint files either by hand, or using different software.

In order to use turnpoint files on your LX Traffic Square, first you need to copy them to the device. In order to do this, you need to have the file saved to the **root of your microSD card**. Once the microSD card is inserted go to **Load** sub-menu and select the file you wish to transfer to the LX Traffic Square's internal memory.

Now go to the **Select** sub-menu and select which of the files in the LX Traffic Square's internal memory you wish to have active.

You can have multiple turnpoint files active at the same time.

NOTE

The LX Traffic Square requires turnpoints in the .cup file format.

5.2.4.2 Airports

Airport files, in the .af file format, are supplied by LX navigation exclusively. For the latest available database files, check the [Support part of LX navigation website](#).

The airports file holds the frequencies to all airports, which is why it is especially important to use the latest database files available. If inconsistencies are found in the files, please refer them to the [LX navigation support email](#).

In order to use a certain airport file, first you need to copy it to the LX Traffic Square's internal memory, through the **Load** sub-menu, and then select it as active through the **Select** sub-menu. Only one airports file can be active at a time.

NOTE

The LX Traffic Square requires airport files in the .af file format.

5.2.4.3 Airspace

Airspace files, in the .cub file format, can be found on both the **LX navigation support** part of webpage, as well as supplied by competition directors, club managers, club mates and other readily available database sources.

In order to use a certain airspace file, first you need to copy it to the LX Traffic Square's internal memory, through the **Load** sub-menu, and then select it as active through the **Select** sub-menu. Multiple airspace files can be selected at once.

NOTE

The LX Traffic Square requires airspace files in the .cub file format.

5.2.4.4 Flarm NET

The LX Traffic Square allows the utilization of **Flarm NET databases**. If a database is used, and a Flarm object with a Flarm ID found in the database shows up, the LX Traffic Square will automatically use the info from the FlarmNET database and assign it to the said object.

5.2.5 Localisation

Contains information regarding the local settings of the LX Traffic Square. In this setup menu the language of the device, timezone and a check box for daylight saving time can be set.

At this moment, the following languages are available:

- **English**
- **Dansk**
- **Deutsch**
- **Italiano**
- **Nederlands**
- **Norsk**
- **Slovenščina**

If you wish to contribute and add your language, contact us at **LX support**.



5.2.6 Service

The Service setup page contains various device and service related settings, as noted below:

- **Device info** - shows basic information regarding the LX Traffic Square:
 - **Serial number**
 - **Firmware version**
 - **Build**
 - **Hardware version**
- **Flarm info** - shows additional info related to the connected Flarm device
 - **Hardware version**
 - **Serial number**
 - **Firmware version**
 - **Database**
 - **Database exp. date** - database expiration date
- **Password** - opens up the dialog for admin passwords.
- **Software update** - used for updating the device. For further information, check the **Performing an update** sub-section for additional info.

The following passwords are at the pilot's disposal:

- **46486** - Deletes all internal files (database files, pilot information, etc.) Can be considered as reverting the device to factory settings.
- **99999** - Empty logbook



Taking care of your LX Traffic Square

If you were taken here by following the link from the introductory part of this manual, you can get back by clicking on the underlined text - [Using this manual](#).

6.1 Display

Leaving the glider canopy open in the sun is known to have a magnifying glass effect, concentrating the sun rays to a smaller area. This can damage the internals of your cockpit, as well as the display of the LX Traffic Square. Applying excessive heat will make the coating of the display start to become yellow and bubble (best case scenario), or destroy the device completely.

This is why it is prudent to always have your canopy, or your instrument panel, covered from direct sunlight.

6.2 Device housing

Visible external damages to the housing of the LX Traffic Square can void your device from a warranty repair.

6.3 RJ connectors

RJ connectors on the back of the LX Traffic Square are used for connecting external devices. If the cable is pulled out, without pressing the plastic security pin, the internals of the LX Traffic Square's connector may break and get ripped out. One should always be careful when taking the cable out, to press the security pin completely.

6.4 microSD card reader

The LX Traffic Square features a microSD card reader on the side of the device. The microSD should always be inserted carefully, not to miss the internal microSD card reader electronics. Sometimes when taking it out, the microSD card can eject, due to the spring-loaded mechanism inside, so the pilot should take care not to lose the card.



6.5 Reverse polarity on power

Although the LX Traffic Square has diodes protecting it from reverse polarity on the main power lines, one should note the RJ connectors are not protected and internal electronics could still get damaged, if a power supply is connected to the wrong pins on the RJ connectors. Similarly, the LX Traffic Square can damage external devices, if a wrong cable is used for connection.

WARNING

GREAT CARE SHOULD BE TAKEN NOT TO CONNECT A CAN CABLE FROM
AN LX DEVICE TO THE FLARM PORT OF THE LX TRAFFIC SQUARE, AS
DAMAGE WILL OCCUR.



Contact

Headquarters

LX navigation d.o.o.
Tkalska ulica 10
SI-3000 Celje
Slovenia

VAT ID

Company is registered in Slovenia,
EU under the VAT ID: SI40539601

Webpage

www.lxnavigation.com

Phone

+386 (0)3 490 46 70

Fax

+386 (0)3 490 46 71

Sales

sales@lxnavigation.com

Support

info@lxnavigation.com



LXNAVIGATION